



TABLE. BED. LOVE.
стильная мебель под заказ

КАТАЛОГ МЕБЕЛИ **VERSECASE**

в каталоге представлен не весь перечень мебели, обратитесь к нам,
Ваш персональный менеджер +79089970970
поможет подобрать необходимые позиции.

индивидуальный подбор стильной мебели для уюта в Вашем доме /
квартире от проверенных производителей Китая
+7 (908) 997-09-70 Владивосток
+86 199 696 00 949 Китай
+7 (900) 324-53-25 Казань

tbl-furniture.ru

诗意廊VERSECASE · 奢石系列

2022年4月

PRODUCT:

2000*1050*740mm (雪山兰/304实心不锈钢)

2400*1100*740mm (雪山兰/304实心不锈钢)

2800*1100*740mm (雪山兰/304实心不锈钢)

诗意廊VERSECASE · 奢石系列



MY-长餐桌-001

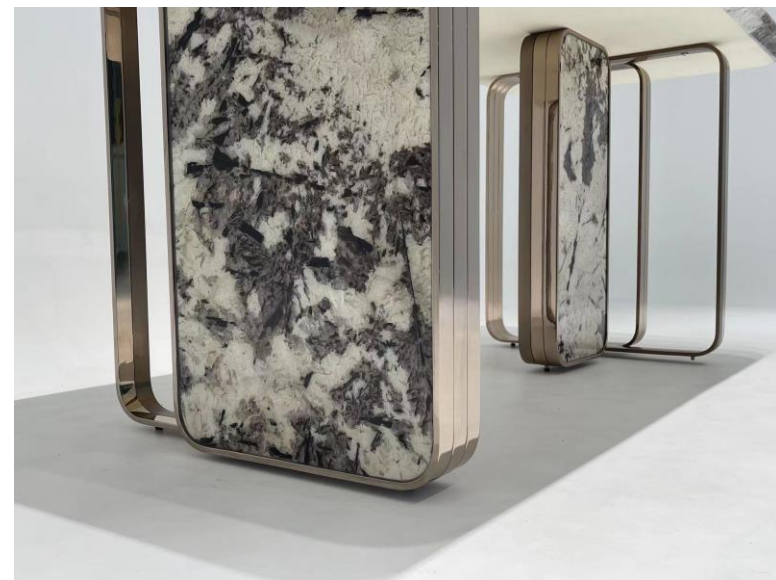

PRODUCT:

1800*900*750MM (鱼肚白/304实心不锈钢)
2000*1000*750MM (鱼肚白/304实心不锈钢)
2200*1100*750MM (鱼肚白/304实心不锈钢)
2400*1100*750MM (鱼肚白/304实心不锈钢)



MY-长餐桌-001

PRODUCT:

1800*900*750mm
2000*1000*750mm
2200*1050*750mm
2400*1100*750mm



MY-长餐桌-002

诗意廊VERSECASE · 奢石系列



PRODUCT:

1800*900*750MM
2000*1000*750MM
2200*1050*750MM
2400*1100*750MM



MY-长餐桌-002

PRODUCT:

1800*900*750mm

2000*1000*750mm

2200*1050*750mm

2400*1100*750mm



MY-长餐桌-003

诗意廊VERSECASE · 奢石系列

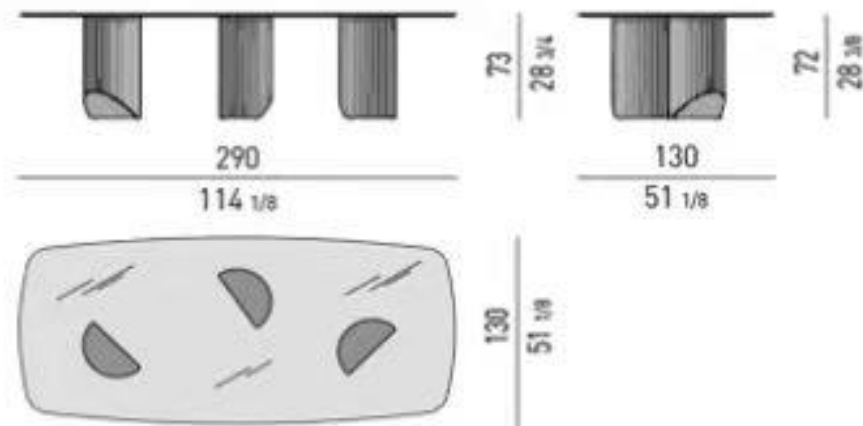

PRODUCT:

1800*900*750mm
2000*1000*750mm
2200*1050*750mm
2400*1100*750mm



MY-长餐桌-003 客户试装实景图

PRODUCT:

1800*900*750mm
2000*1000*750mm
2200*1050*750mm
2400*1100*750mm

诗意廊VERSECASE·奢石系列

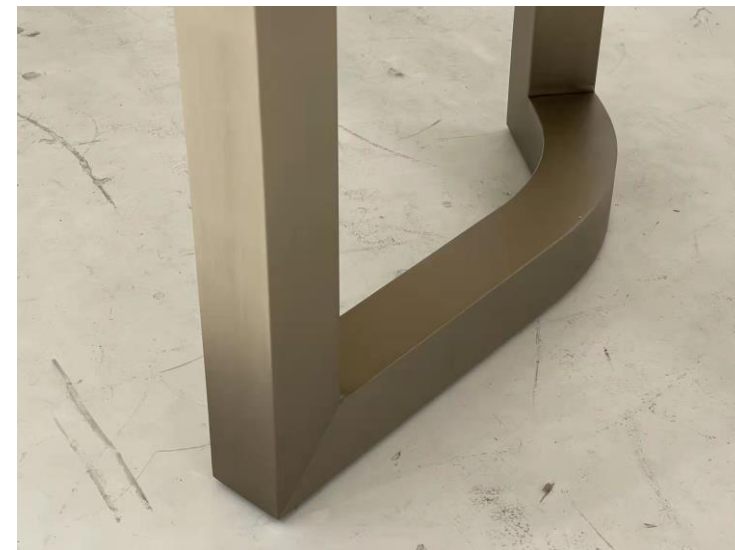

MY-长餐桌-004

PRODUCT:

1800*900*750mm

2000*1000*750mm

2200*1050*750mm

2400*1100*750mm

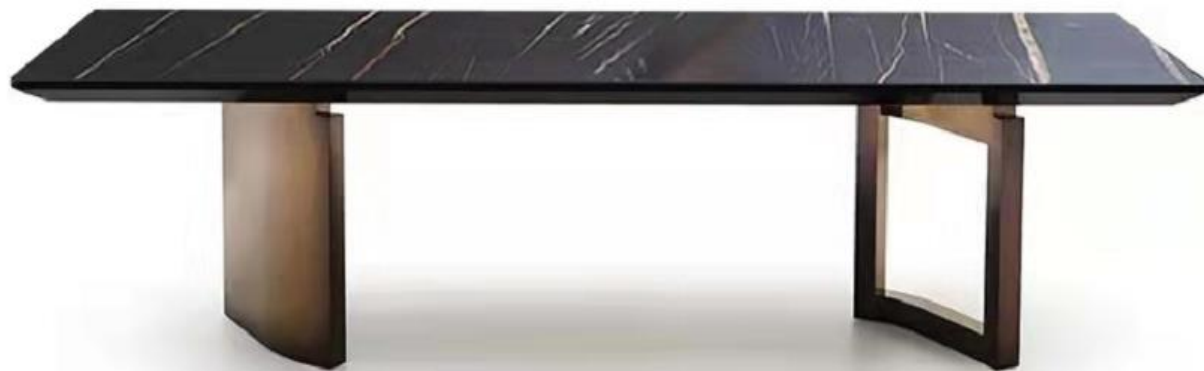

MY-长餐桌-004客户试装实景图

PRODUCT:

1800*900*750mm

2000*1000*750mm

2200*1050*750mm

2400*1100*750mm

诗意廊VERSECASE·奢石系列



MY-长餐桌-005

PRODUCT:

1800*900*750mm

2000*1000*750mm

2200*1050*750mm

2400*1100*750mm



MY-长餐桌-005

PRODUCT:

1800*900*750mm

2000*1000*750mm

2200*1050*750mm

2400*1100*750MM



MY-长餐桌-006

PRODUCT:

1800*900*750MM
2000*1000*750MM
2200*1050*750MM
2400*1100*750MM



MY-长餐桌-007

PRODUCT:

2200*1050*750 (寒江雪/实心不锈钢)



MY-长餐桌-008

PRODUCT:

2200*1050*750 (芬迪白/不锈钢)

2200*1050*750 (潘多拉/不锈钢)



MY-长餐桌-009

PRODUCT:

2000*1000*750mm (潘多拉/仿古不锈钢)

2200*1050*750mm (潘多拉/仿古不锈钢)

2400*1100*750mm (潘多拉/仿古不锈钢)

诗意廊VERSECASE · 奢石系列



MY-长餐桌-0010

PRODUCT:

2000*1000*750mm (潘多拉/仿古不锈钢)

2200*1050*750mm (潘多拉/仿古不锈钢)

2400*1100*750mm (潘多拉/仿古不锈钢)



MY-长餐桌-0010 成品试装图

PRODUCT:

2400*1100*750mm

2400*800*750mm



MY-长餐桌-0011

PRODUCT:

1800*900*750mm

2000*1000*750mm

2200*1050*750mm

2400*1100*750mm

诗意廊VERSECASE · 奢石系列

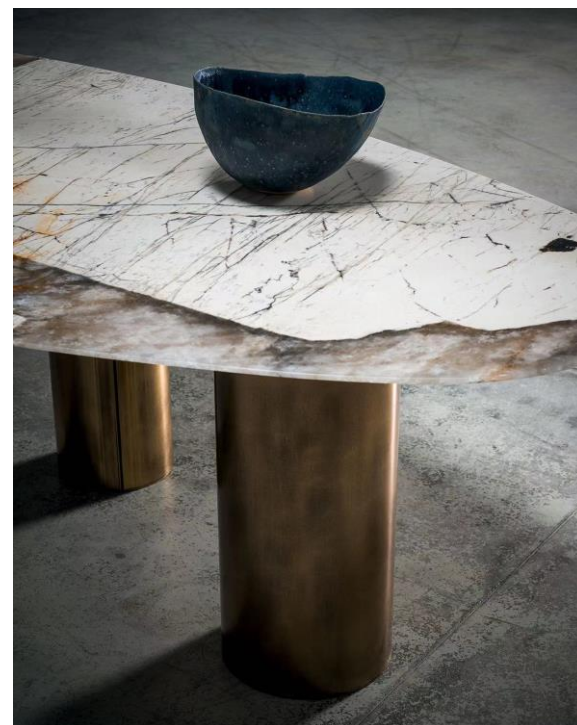

MY-长餐桌-0012

PRODUCT:

1800*900*750mm
2000*1000*750mm
2200*1050*750mm
2400*1100*750mm

诗意廊VERSECASE·奢石系列

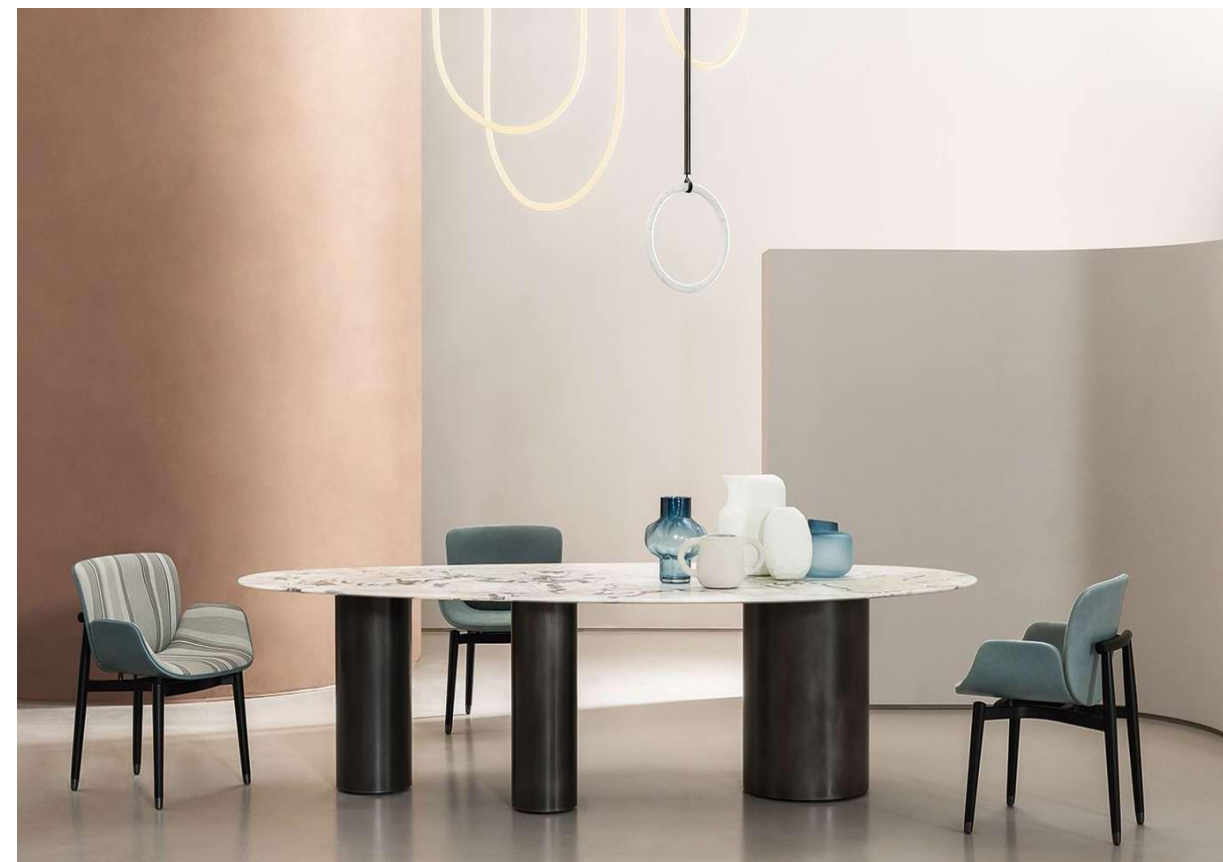

MY-长餐桌-0012客户成品试装图

PRODUCT:

1800*900*750MM
2000*1000*750MM
2200*1050*750MM
2400*1100*750MM
2600*1100*750MM
2800*1200*750MM



MY-长餐桌-0013

PRODUCT:

1800*900*750mm
2000*1000*750mm
2200*1050*750mm
2400*1100*750mm



MY-长餐桌-0014

诗意廊VERSECASE • 奢石系列

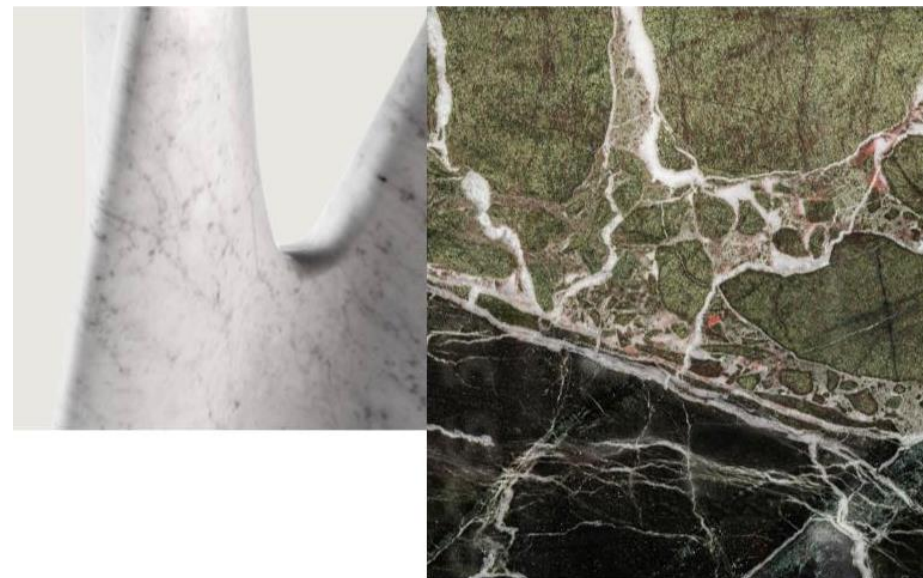

Detail of the tree shaped base made from Carrara marble.
Detail of the Verde Casaperta marble top characterized by a deep sage green with darker shades of green crossed by light veins and little red flecks.



PRODUCT:

1800*900*750mm

2000*1000*750mm

2200*1050*750mm

2400*1100*750mm



MY-长餐桌-0014

PRODUCT:

诗意廊VERSECASE·奢石系列

1800*900*750mm

2000*1000*750mm

2200*1050*750mm

2400*1100*750mm



MY-长餐桌-0015

PRODUCT:

1800*900*750MM
2000*1000*750MM
2200*1050*750MM
2400*1100*750MM



MY-长餐桌-0016

PRODUCT:

1800*900*750mm

2000*1000*750mm

2200*1050*750mm

2400*1100*750mm

诗意廊VERSECASE · 奢石系列

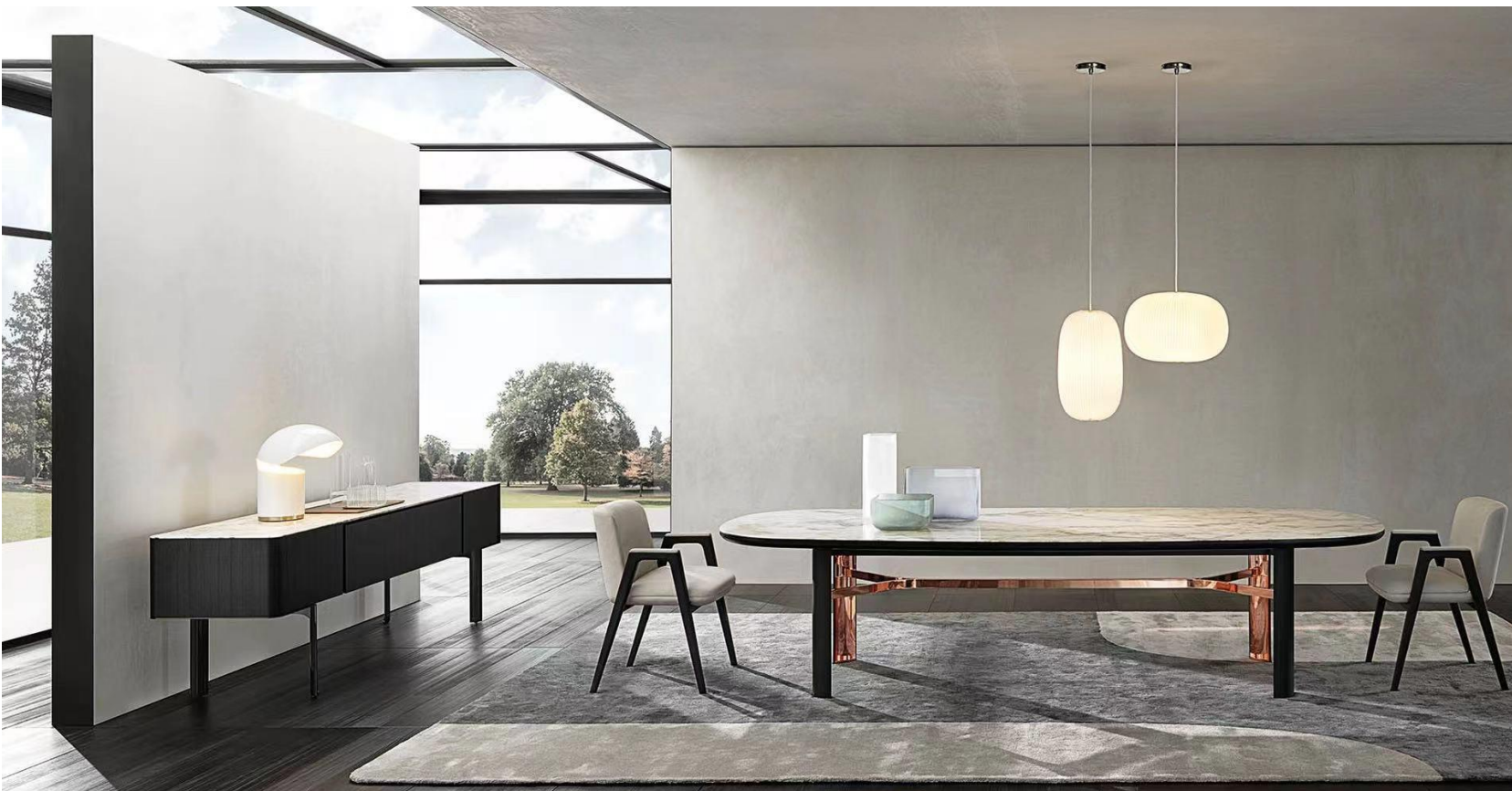

MY-长餐桌-0017

PRODUCT:

1800*900*750mm
2000*1000*750mm
2200*1050*750mm
2400*1100*750mm



MY-长餐桌-0017客户成品试装图

PRODUCT:

1800*900*750MM
2000*1000*750MM
2200*1050*750MM
2400*1100*750MM



MY-长餐桌-0018

PRODUCT:

Ø1500 (转盘850) *750mm

Ø1800 (转盘1100) *750mm

Ø2000 (转盘1200) *750mm

诗意廊VERSECASE · 奢石系列



MY-圆餐桌-001

PRODUCT:

Ø1500 (转盘850) *750mm

Ø1800 (转盘1100) *750mm

Ø2000 (转盘1200) *750mm



MY-圆餐桌-001成品试装图

PRODUCT:

Ø1500 (转盘850) *750MM (实心不锈钢)

Ø1800 (转盘1100) *750MM (实心不锈钢)

Ø2000 (转盘1200) *750MM (实心不锈钢)



MY-圆餐桌-002

PRODUCT:

Ø1500 (转盘850) *750mm
Ø1800 (转盘1100) *750mm
Ø2000 (转盘1200) *750mm



MY-圆餐桌-003

PRODUCT:

Ø1500 (转盘850) *750mm

Ø1800 (转盘1100) *750mm

Ø2000 (转盘1200) *750mm



MY-圆餐桌-003 成品试装图

PRODUCT:

Ø1500 (转盘850) *750mm

Ø1800 (转盘1100) *750mm

Ø2000 (转盘1200) *750mm

诗意廊VERSECASE · 奢石系列



MY-圆餐桌-004

PRODUCT:

Ø1500 (转盘850) *750mm
Ø1800 (转盘1100) *750mm
Ø2000 (转盘1200) *750mm

诗意廊VERSECASE · 奢石系列



MY-圆餐桌-004客户成品试装图

PRODUCT:

Ø1500 (内嵌转盘800) *750mm (不锈钢管底座)
Ø1800 (内嵌转盘1100) *750mm (不锈钢管底座)
Ø2000 (内嵌转盘1200) *750mm (不锈钢管底座)

诗意廊VERSECASE · 奢石系列



MY-圆餐桌-005



PRODUCT:

- Ø1500 (内嵌转盘800) *750mm (不锈钢管底座)
- Ø1800 (内嵌转盘1100) *750mm (不锈钢管底座)
- Ø2000 (内嵌转盘1200) *750mm (不锈钢管底座)

诗意廊VERSECASE · 奢石系列



MY-圆餐桌-005



PRODUCT:

诗意廊VERSECASE·奢石系列

Ø1500 (转盘850) *750mm
Ø1800 (转盘1100) *750mm
Ø2000 (转盘1200) *750mm



MY-圆餐桌-006

PRODUCT:

诗意廊VERSECASE·奢石系列

Ø1500 (转盘850) *750MM
Ø1800 (转盘1100) *750MM
Ø2000 (转盘1200) *750MM



MY-圆餐桌-007

PRODUCT:

Ø1500 (内嵌转盘850) *750mm
Ø1800 (内嵌转盘1100) *750mm
Ø2000 (内嵌转盘1200) *750mm

诗意廊VERSECASE · 奢石系列



MY-圆餐桌-008

PRODUCT:

Ø1500 (内嵌转盘850) *750mm
Ø1800 (内嵌转盘1100) *750mm
Ø2000 (内嵌转盘1200) *750mm

诗意廊VERSECASE · 奢石系列



MY-圆餐桌-008

PRODUCT:

Ø1350 (转盘700) *750MM

Ø1500 (转盘850) *750MM

Ø1800 (转盘1100) *750MM

Ø2000 (转盘1200) *750MM

诗意廊VERSECASE·奢石系列



MY-圆餐桌-009

PRODUCT:

Ø1350 (转盘700) *750mm
Ø1500 (转盘850) *750mm
Ø1800 (转盘1100) *750mm
Ø2000 (转盘1200) *750mm

诗意廊VERSECASE·奢石系列



MY-圆餐桌-009成品试装图

PRODUCT:

Ø1500 (转盘850) *750mm
Ø1800 (转盘1100) *750mm
Ø2000 (转盘1200) *750mm



MY-圆餐桌-0010

诗意廊VERSECASE · 奢石系列



PRODUCT:

诗意廊VERSECASE·奢石系列

Ø1500 (转盘850) *750mm
Ø1800 (转盘1100) *750mm
Ø2000 (转盘1200) *750mm



MY-圆餐桌-0010成品试装图

PRODUCT:

Ø1500 (转盘850) *750mm Ø1800 (转盘1100) *750mm
Ø2000 (转盘1200) *750mm Ø2200 (转盘1400) *750mm
Ø2500 (转盘1600) *750mm Ø2800 (转盘1900) *750mm

诗意廊VERSECASE · 奢石系列



MY-圆餐桌-0011

PRODUCT:

Ø1500 (转盘850) *750mm

Ø2000 (转盘1200) *750mm

Ø2500 (转盘1600) *750mm

Ø1800 (转盘1100) *750mm

Ø2200 (转盘1400) *750mm

Ø2800 (转盘1900) *750mm

诗意廊VERSECASE·奢石系列



MY-圆餐桌-0011成品试装图

PRODUCT:

诗意廊VERSECASE·奢石系列



MY-圆餐桌-0012

PRODUCT:

Ø1500*750mm



MY-圆餐桌-0012

PRODUCT:

Ø1500 (转盘850) *750MM
Ø1800 (转盘1100) *750MM
Ø2000 (转盘1200) *750MM



MY-圆餐桌-0013

PRODUCT:

Ø1380*750 (深啡/小蛮腰)

诗意廊VERSECASE · 奢石系列

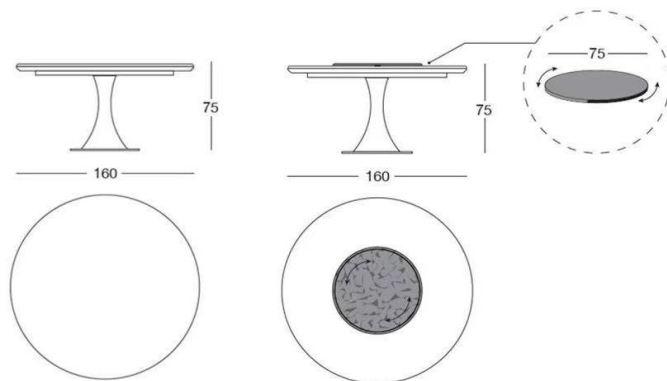

MY-圆餐桌-0014

PRODUCT:

Ø1380*750 (深啡/小蛮腰)

诗意廊VERSECASE·奢石系列



MY-圆餐桌-0014

诗意廊VERSECASE·奢石系列

PRODUCT:

Ø1500 (转盘850) *750mm

Ø1800 (转盘1100) *750mm

Ø2000 (转盘1200) *750mm



MY-圆餐桌-0015

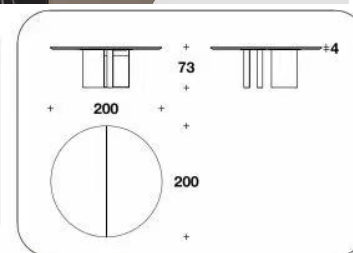
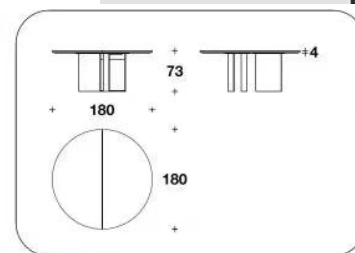
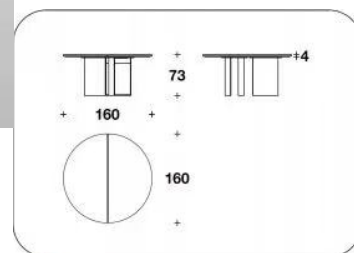

PRODUCT:

Ø1500 (转盘850) *750mm

Ø1800 (转盘1100) *750mm

Ø2000 (转盘1200) *750mm



MY-圆餐桌-0015

PRODUCT:

Ø1350*750mm

Ø1500*750mm

诗意廊VERSECASE · 奢石系列



MY-圆餐桌-0016

PRODUCT:

Ø1350*750mm

Ø1500*750mm



MY-圆餐桌-0016

PRODUCT:

Ø1500 (转盘850) *750MM
Ø1800 (转盘1100) *750MM
Ø2000 (转盘1200) *750MM

诗意廊VERSECASE·奢石系列



MY-圆餐桌-0017



PRODUCT:

Ø1500 (转盘850) *750MM
Ø1800 (转盘1100) *750MM
Ø2000 (转盘1200) *750MM

诗意廊VERSECASE · 奢石系列



MY-圆餐桌-0017

PRODUCT:

Ø1500 (内嵌转盘770) *750mm

Ø1800 (内嵌转盘1100) *750mm

Ø2000 (内嵌转盘1200) *750mm



MY-圆餐桌-0018

诗意廊VERSECASE·奢石系列

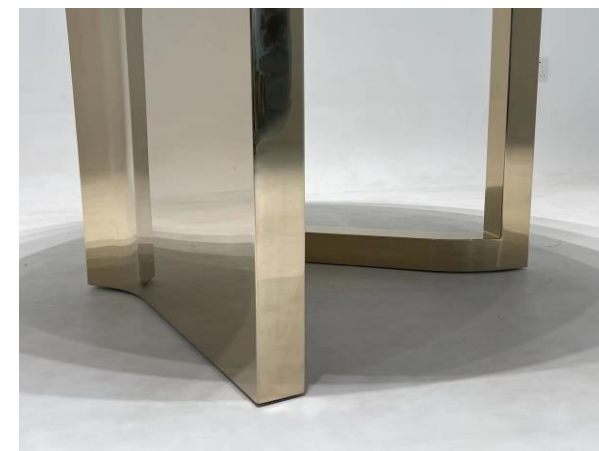

PRODUCT:

Ø1500 (内嵌转盘770) *750mm

Ø1800 (内嵌转盘1100) *750mm

Ø2000 (内嵌转盘1200) *750mm

诗意廊VERSECASE·奢石系列



MY-圆餐桌-0018成品试装图

PRODUCT:

Ø1350*750MM

Ø1500 (转盘850) *750MM



MY-圆餐桌-0019

PRODUCT:

Ø1500*750MM

Ø1800*750MM



MY-圆餐桌-0020

PRODUCT:

Ø1500 (内嵌转盘800) *750MM

Ø1800 (内嵌转盘1100) *750MM



MY-长餐桌-0021

PRODUCT:

Ø1500 (转盘850) *750MM
Ø1800 (转盘1100) *750MM
Ø2000 (转盘1200) *750MM



MY-长餐桌-0022

PRODUCT:

1600*800*420

1600*800*420

诗意廊VERSECASE · 奢石系列



MY-茶几-001



PRODUCT:

1600*800*420 (寒江雪/实心不锈钢)

1600*800*420 (亚马逊绿/实心不锈钢)

诗意廊VERSECASE · 奢石系列



MY-茶几-001试装实物图

PRODUCT:

2398*839*720MM (云中翡翠)

2398*839*720MM (香雪梅)

诗意廊VERSECASE · 奢石系列



MY-财源滚滚茶台-001 (网格款)

PRODUCT:

2398*839*720MM (香雪梅, 软包底座)

2398*839*720MM (香雪梅, 石墩底座)



MY-财源滚滚茶台-002 (立柱款)

PRODUCT:

1850*700*720MM (雪山飞狐)

1850*700*720MM (黑金蓝金沙)

诗意廊VERSECASE · 奢石系列



MY-金碧辉煌茶台-001

PRODUCT:

1850*700*720MM (香雪梅)

1850*700*720MM (云中翡翠)

诗意廊VERSECASE · 奢石系列



MY-小蛮腰茶台-001

PRODUCT:

1800*900*750mm

2000*1000*750mm

2200*1050*750mm

2400*1100*750mm



MY-金玉满堂茶台-001

PRODUCT:

2360*1100*750MM

诗意廊VERSECASE·奢石系列



MY-玛雅原创茶台-001

PRODUCT:

1200*800*260mm

1500*800*260mm

诗意廊VERSECASE · 奢石系列



MY-茶几-002

PRODUCT:



MY-茶几-003

PRODUCT:



MY-茶几-004

PRODUCT:

Ø900*370MM
Ø500*450MM

诗意廊VERSECASE · 奢石系列



MY-茶几-005

PRODUCT:

1200*900*360mm
750*750*480mm

诗意廊VERSECASE·奢石系列



MY-茶几-006

PRODUCT:

1200*700*320MM



MY-茶几-007

PRODUCT:

诗意廊VERSECASE·奢石系列

1300*850*360 (鱼肚金/黑橡)

1300*850*360 (爵士白/黑橡)



MY-茶几-008

PRODUCT:

1300*700*420mm

诗意廊VERSECASE·奢石系列



MY-茶几-009

PRODUCT:

诗意廊VERSECASE·奢石系列

组合茶几:

2000*350*350 (卡拉拉白)
1530*350*260 (卡拉拉白)
1060*350*390 ((卡拉拉白)



MY-茶几-0010

PRODUCT:

Ø800*400mm



MY-茶几-0011

PRODUCT:

诗意廊VERSECASE·奢石系列

1300*800*380 (潘多拉)

900*700*280 (潘多拉)



MY-茶几-0012

PRODUCT:

Ø1090*460(春华秋实)

Ø790*530(卡里冰玉)



MY-茶几-0013

PRODUCT:

450*300*550mm

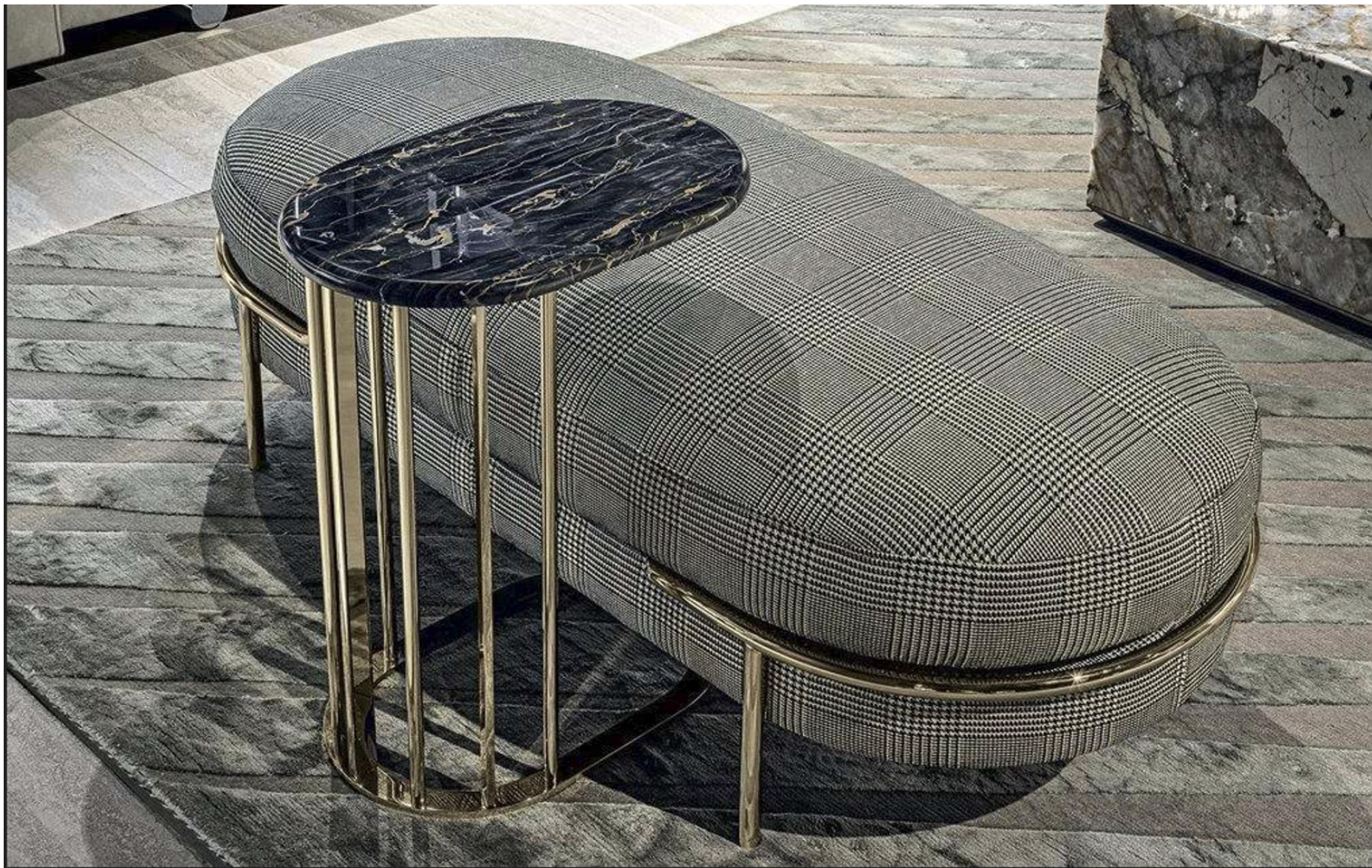

MY-茶几-0014

PRODUCT:

Ø920*320mm

Ø920*420mm



MY-茶几-0015

PRODUCT:

Ø1200*450mm



MY-茶几-0016

PRODUCT:

Ø1200*450mm
Ø950*250mm



MY-茶几-0017

PRODUCT:

Ø600*700mm



MY-茶几-18

PRODUCT:

1100*900*350mm

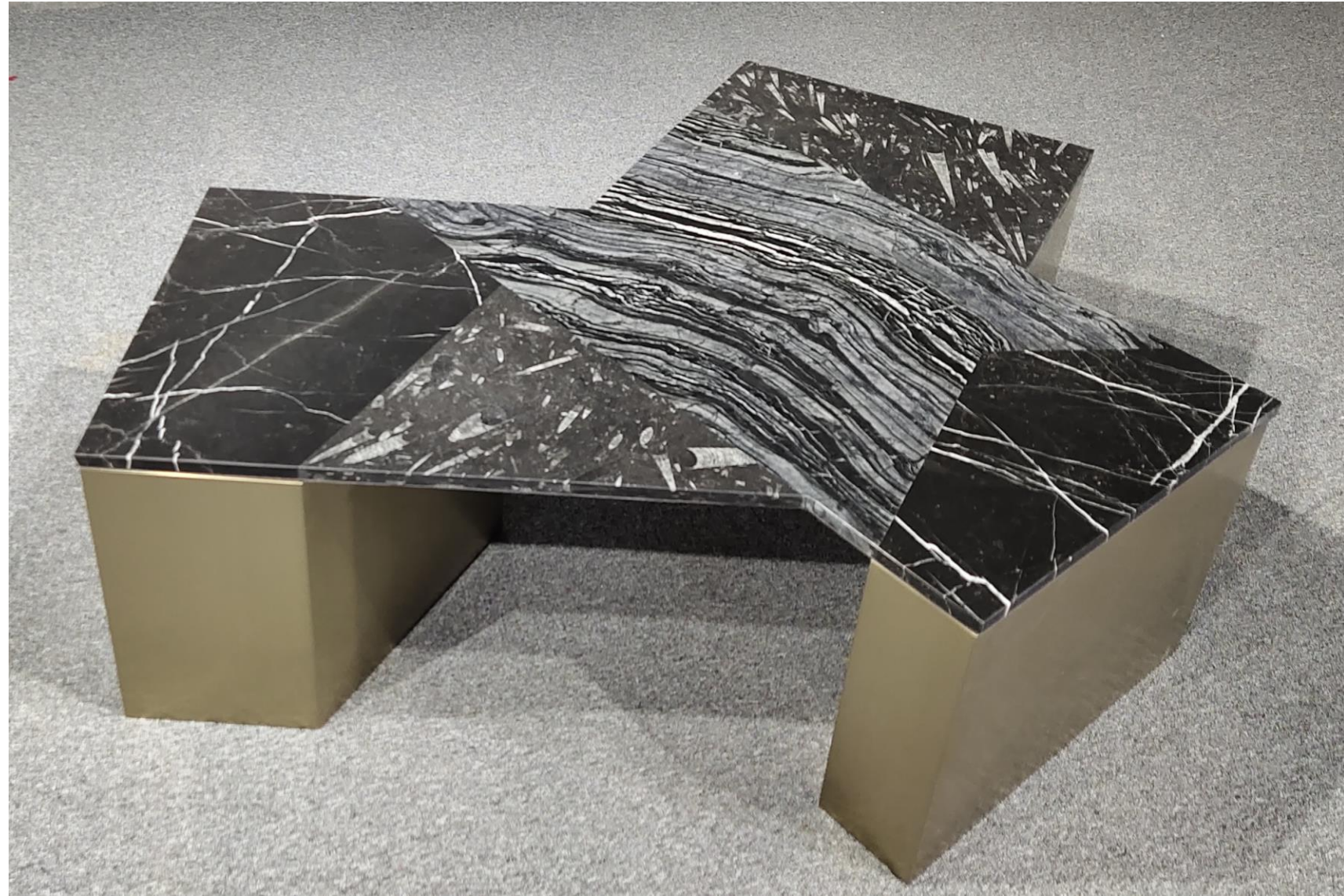

MY-茶几-19

PRODUCT:

1500*800*420MM



MY-茶几-20

PRODUCT:

Ø500*350mm

Ø800*420mm

Ø500*500mm



MY-茶几-0021

PRODUCT:

Ø1000*400mm



MY-茶几-0022

PRODUCT:

诗意廊VERSECASE·奢石系列

900*900*370 (劳伦黑金/拉丝不锈钢)



MY-茶几-0023

PRODUCT:



MY-茶几-0024

PRODUCT:

500*500*420mm



MY-边几-001

PRODUCT:

600*600*580mm



MY-边几-002

PRODUCT:

480*400*350mm



MY-边几-003

PRODUCT:

Ø400*460mm

Ø300*530mm



MY-边几-004

PRODUCT:

536*536*500mm



MY-边几-005

PRODUCT:

Ø580*560mm



MY-边几-006

PRODUCT:

Ø400*580mm



MY-边几-007

PRODUCT:

Ø400*580mm



MY-边几-008

PRODUCT:

1450*420*900 (亚马逊绿)



MY-玄关-001

PRODUCT:

1300*390*850mm

诗意廊VERSECASE·奢石系列

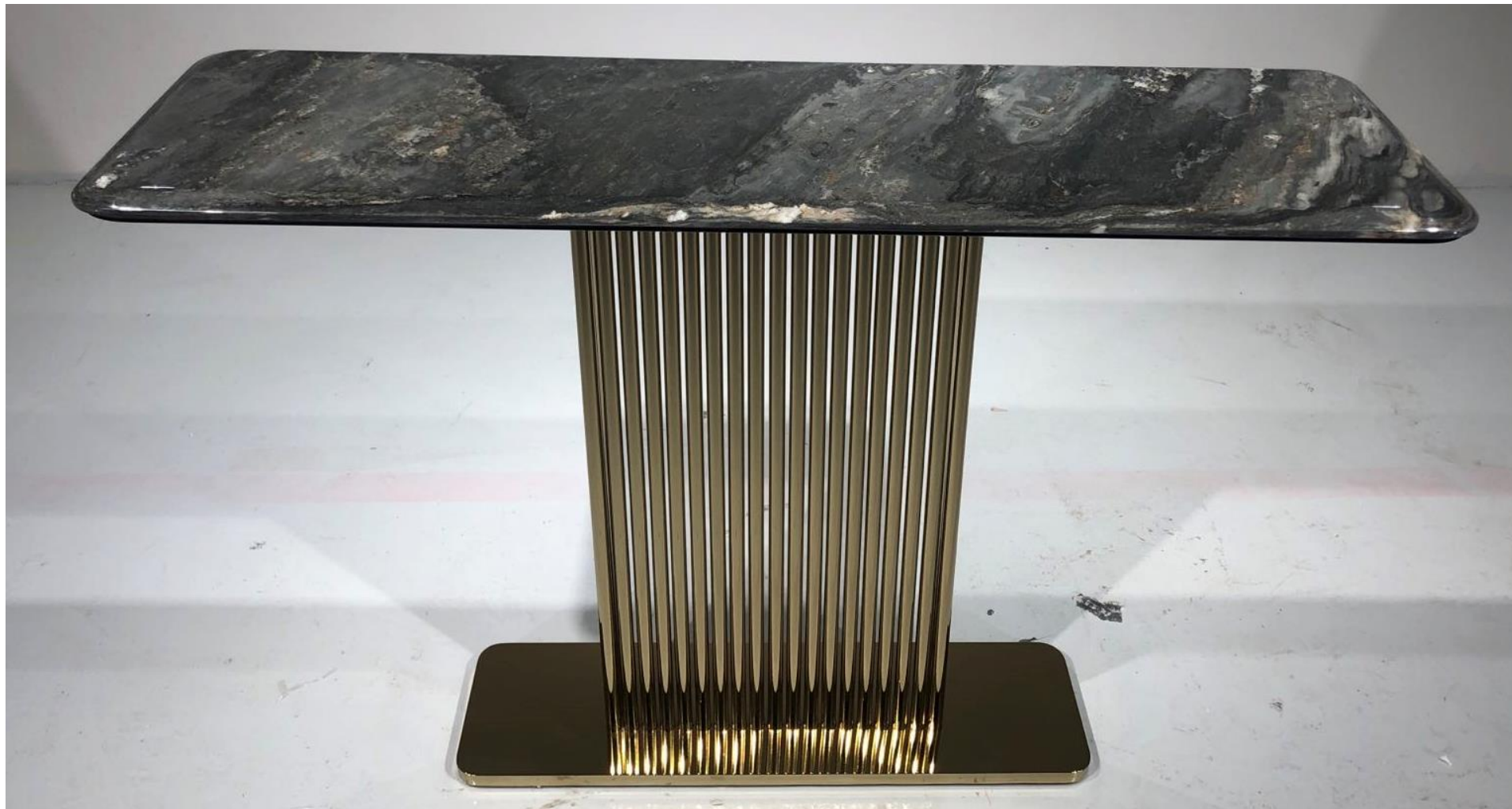

MY-玄关-002

PRODUCT:

1600*350*900 (寒江雪+镜面不锈钢)



MY-玄关-003

PRODUCT:

1420*420*850mm



MY-玄关-004

PRODUCT:

1200*490*480 (寒江雪)



MY—玄关-005

PRODUCT:

1500*400*860mm



MY-玄关-006

PRODUCT:

1600*350*880mm



MY-玄关-007

PRODUCT:



MY-椅子-001

PRODUCT:



MY-椅子-002

PRODUCT:



MY-椅子-003

PRODUCT:



MY-椅子-004

PRODUCT:



MY-椅子-005

PRODUCT:



诗意廊VERSECASE · 奢石系列

MY-椅子-006

PRODUCT:



MY-椅子-007

PRODUCT:



MY-椅子-008

PRODUCT:



MY-椅子-009

PRODUCT:

830*380*650mm



MY-茶柜-001

PRODUCT:

830*380*650mm



MY-茶柜-002

PRODUCT:
MY-BJ-001
Ø450*H580 (底座Ø200*150)

诗意廊VERSECASA



广西白



爵士白

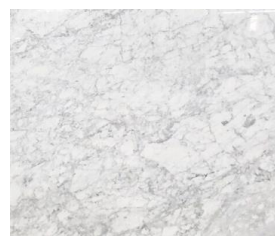

中花白



雪花白



香雪梅



熊猫白



白金沙

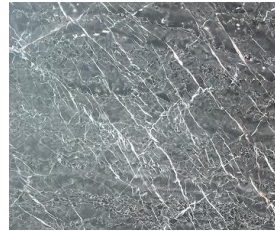

杭灰



温德姆灰



黑白根

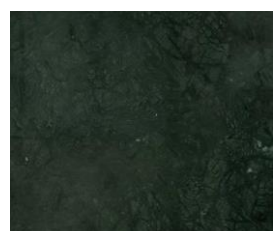

印度绿



拼接蓝宝石



云中翡翠



冷翡翠



深啡网



XM-BJ-001

PRODUCT:
XM-BJ-002
Ø450*H580 (底座Ø240)

诗意廊VERSECASA



广西白



爵士白

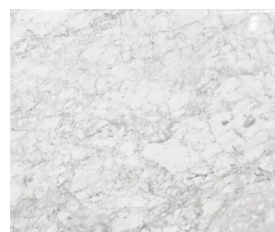

中花白



雪花白



香雪梅



熊猫白

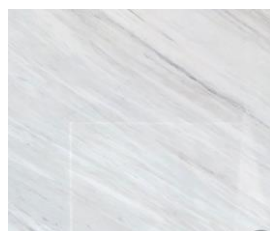

白金沙



杭灰



温德姆灰



黑白根

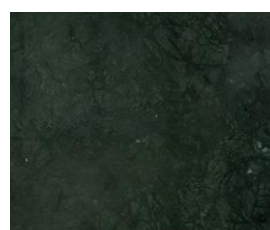

印度绿

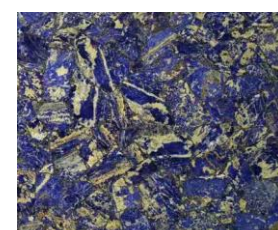

拼接蓝宝石



云中翡翠



冷翡翠



深啡网



XM-BJ-002

PRODUCT:
XM-BJ-003
Ø450*H580 (底座Ø200*150)

诗意廊VERSECASA



广西白



爵士白

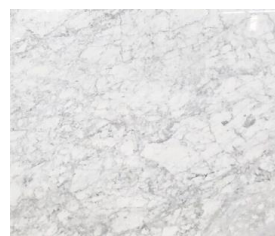

中花白



雪花白

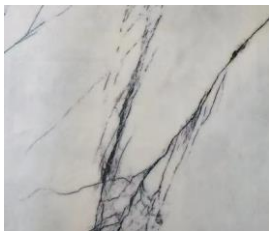

香雪梅



熊猫白

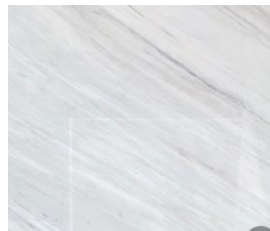

白金沙

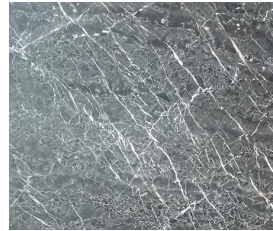

杭灰

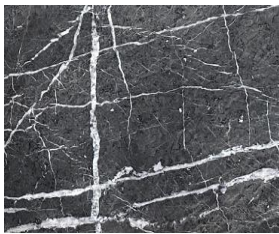

温德姆灰



黑白根



印度绿



拼接蓝宝石



云中翡翠



冷翡翠



深啡网



XM-BJ-003

PRODUCT:
XM-BJ-004
Ø450*H580 (底座Ø240)

诗意廊VERSECASA



广西白



爵士白

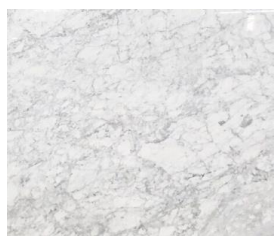

中花白



雪花白

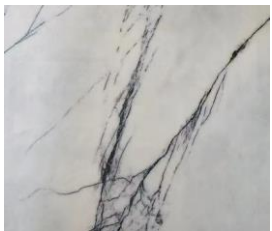

香雪梅



熊猫白



白金沙

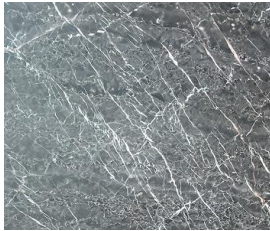

杭灰

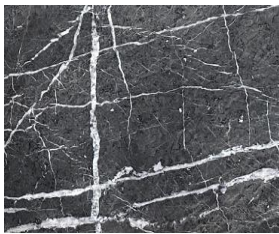

温德姆灰



黑白根



印度绿

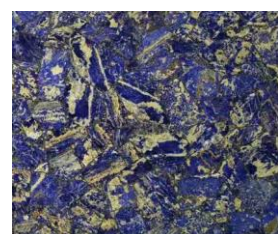

拼接蓝宝石

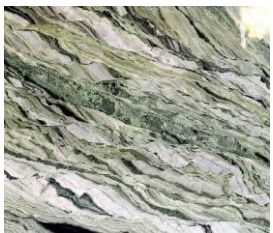

云中翡翠



冷翡翠



深啡网

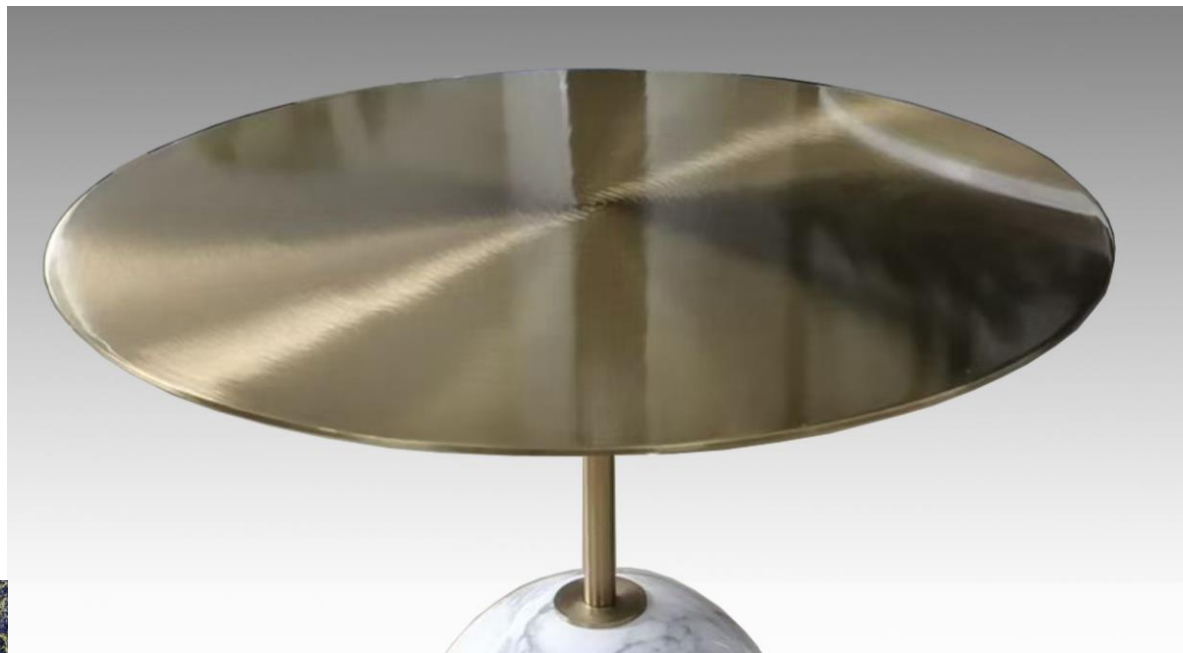

XM-BJ-004